

# GAS SPRINGS





### UNIQUE STANDARD RANGE

Our standard range of gas springs comprises of 900 different items that can be combined with some hundred end fittings and accessories.

The standard range and end fittings for conventional gas springs can be found on pages 157-194.

Our standard range of lockable gas springs and accessories can be found on pages 196-202.

We are also able to offer custom gas springs manufactured to your specific requirements. More information about the custom variants we produce can be found on pages 155 and 197.

You can also visit our website, [www.lesjoforsab.com](http://www.lesjoforsab.com), which features all the latest product news.

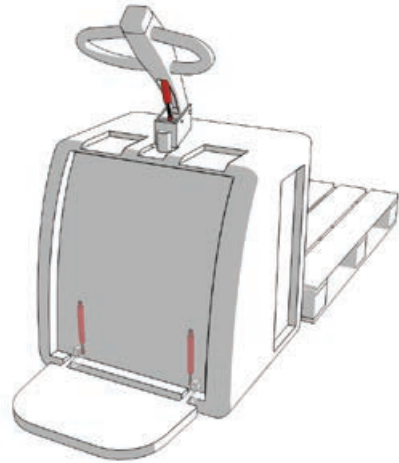

### FIELDS OF APPLICATION

Lesjöfors gas springs are usually used for lifting and unloading, but their special spring and dampening characteristics mean that the number of applications in which they may be used is quite extensive.

Typical areas of use include controlled opening and closing of doors and hoods. But they can be equally adept at controlling complete equipment such as ventilation apertures, chairs, beds, windows, tools and machinery. Even heavy items can be lifted by hand with the help of a gas spring.



### TECHNICAL INFORMATION

The main components of a gas spring are a tube, a piston rod with piston head, a seal and a guide. The tube is filled with compressed nitrogen gas, which applies equal pressure on both sides of the piston. The surface of the piston rod side of the piston is smaller than on the opposing side, producing a pushing force.

In simple terms, the magnitude of the driving force is determined by the cross-sectional area of the product's piston rod and the internal pressure inside the tube.

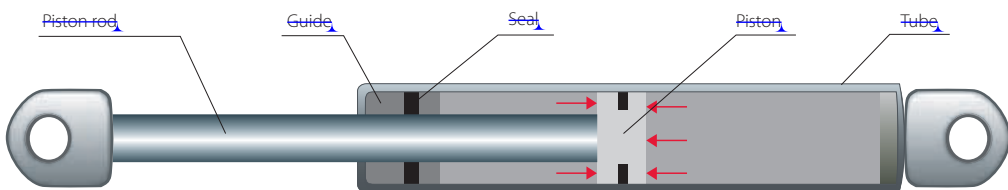

# GAS SPRINGS

## General information

### Spring characteristics

In contrast to most other types of spring, gas springs have a built-in pre-tension force and a flat spring characteristic. This means that there is only a small difference in force between full extension and full compression.

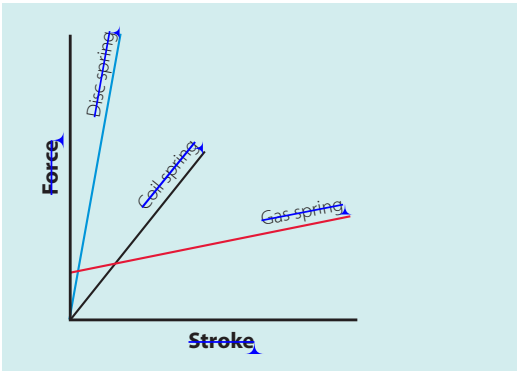

As the piston rod is pressed into the tube, volume reduces and pressure increases. This causes pushing force to increase. In conventional gas springs, this increase is normally around 30% at full compression.

The diagram below illustrates, in simple terms, forces  $F_3$ ,  $F_4$ ,  $F_2$  and  $F_1$  along the stroke when the gas spring is fully compressed and then released.

$F_1$  indicates the force just before full extension. It is this static  $F_1$  force we refer to when we talk about the force of a gas spring. The difference between force pairs  $F_3/F_1$  and  $F_4/F_2$  varies according to the amount of friction.

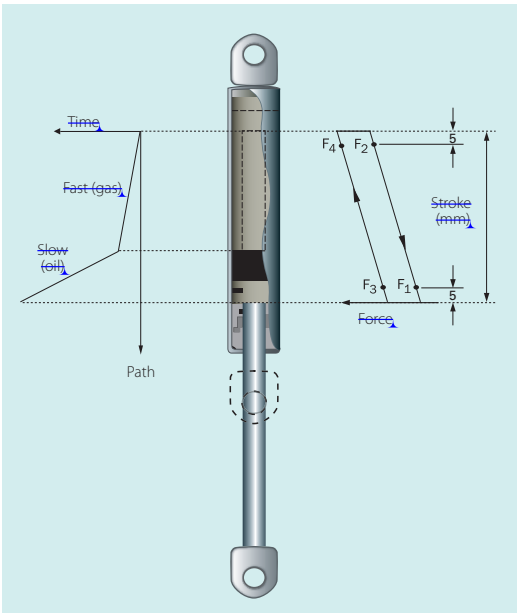

### Hydraulic damping

The pushing spring movement is slow and controlled. It is reliant on the gas flow between the piston sides being allowed to pass through channels in the piston during the stroke.

Conventional gas springs use 'hydraulic damping', which involves a small amount of oil slowing down the speed of the stroke immediately before the spring reaches full extension. This imbues the movement with a braking character at the end position (provided that the piston rod is in the downward direction).

### Which gas spring should I choose for my application?

Using a software package developed in-house, Lesjöfors is able to simulate any type of application imaginable, enabling us to quickly help calculate the force requirement for your particular design. Contact your local representative for professional advice.

In simpler cases, the required spring force may be calculated by entering relevant values into the following formula:

$$F_1 = \frac{G \times L}{W \times n} + 10 - 15\% \text{ margin of error}$$

$$F_1 = \text{Gas spring force in Newtons}$$

$$G = \text{Gravitational pull in Newtons of the moving part}$$

$$C = \text{Connection point on the moving part}$$

$$D = \text{Connection point on the fixed part}$$

$$E = \text{Swivel point}$$

$$S = \text{Centre of gravity}$$

$$L = \text{Horizontal distance from E to S in open position}$$

$$W = \text{Smallest distance to E}$$

$$n = \text{Number of gas springs}$$

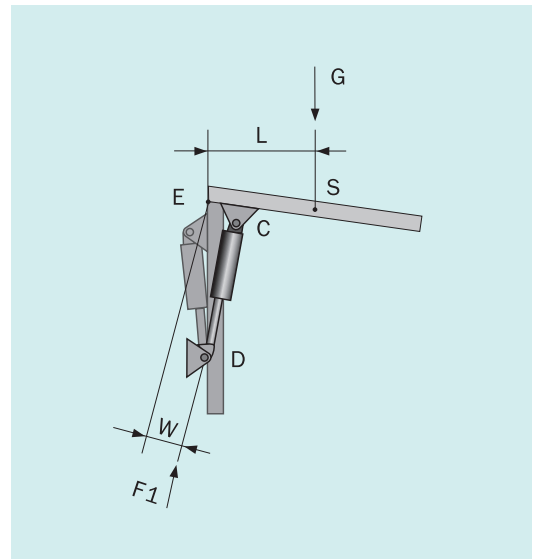



### Force tolerances

Tolerances when charging with gas and other factors mean that there may be variations in the force exerted by gas springs with the same nominal F1 value. The tolerances in the table below are excessive; the actual forces are usually very close to the nominal specification.

#### Force tolerance (N)

$F1 \leq 100$	$\pm 10$
$100 < F1 \leq 200$	$\pm 20$
$200 < F1 \leq 600$	$\pm 30$
$600 < F1 \leq 1200$	$\pm 50$
$F1 > 1200$	$\pm 100$

The nominal F1 values apply at 20 °C, which is the temperature at which gas charging is carried out.

Note that if the ambient temperature rises or falls, the force of the gas spring rises or falls depending on pressure changes in the tube.

As a rule of thumb, gas spring force increases by approximately 3.5% per 10 °C temperature increase and reduces accordingly when the temperature falls.

### Working life of the gas spring

Lesjöfors gas springs are generally permitted to have a maximum force loss of 10% after 40000 oscillations at a max of five oscillations per minute at room temperature and in ideal fitting circumstances.

However, it must be remembered that gas springs have a shelf life as the sealing material ages and wears out.

There are several factors that affect gas spring lifespan in an application.

External factors such as temperature changes and other physical environmental influences can affect seal aging and wear and thereby speed up the process of force loss.

In addition, fitting also plays a significant role. If, for a majority of its operational life, a gas spring has its piston rod pointing downwards, the seals and the piston rod will be kept lubricated with oil, thus minimising wear and leakage. A gas spring will also last longer if it is fitted free from vibrations and in such a way that no lateral forces can be produced.

A good rule for a designer is to always choose a gas spring with the largest possible tube volume for the amount of force required.

### CUSTOM RANGE

Lesjöfors has decades of experience of choosing the right gas spring for various requirements. This means that we can be a one-stop partner who can be on board right from the design stage. If our huge standard range does not cover a specific force or otherwise does not satisfy a specific requirement you have, we offer the following custom variants.

### Length and force

The gas springs and accessories that form part of Lesjöfors' standard stock are manufactured to standardised strokes, total lengths and forces. We can also supply springs with other dimensions and forces upon request, within the technical limitations.

### Movement and damping

We can also adapt pushing speed and oil volume, which means that we can tailor movement patterns and damping to your requirements.

### Tube colour and finish

Except for our stainless steel range, the tube of our gas springs is painted in black RAL9005 and the piston rod finished in black nitrite. However, the piston rod may also be finished in chrome, and the tube may be painted any colour you choose.

### Connectors

The catalogue range includes threaded connectors or welded loops that have been generally adopted by the market. However, we can produce gas springs with alternative connector types or offer custom end fittings if necessary.

### Other product types

Lesjöfors can also supply the following products that are based on conventional gas spring design but do not appear in the standard range.

#### Gas spring with dynamic damping

A longitudinal groove on the inside of the tube controls stroke speed and can be adapted for various movement requirements. One advantage with dynamic damping is that braking can be achieved without the piston rod pointing downwards.

#### Damper

In this product, the tube is filled with oil and can, for example, be used to slow down a falling hatch or other components that must be dampened during movement.

# GAS SPRINGS

## General information

### USER ADVICE

1. A gas spring is a pressure vessel. Never try to open one without following the instructions in the section entitled "Recycling". Never expose a gas spring to excessive heat or naked flames.
2. To ensure the optimal function and lifespan, conventional gas springs should be fitted so that the piston rod always, or as frequently as possible, points downwards during use. If the piston rod is down at the end of the stroke, the hydraulic damping is used to the full.
3. Gas springs must not, under any circumstances, be exposed to damaging external influences or violent handling. Lesjöfors accepts no warranty or return liability for the following:
  - a. Visible damage to the piston rod, including minor scratching, paint dust, bending or similar. This may damage seal function.
  - b. A damaged tube. This may mean that functionality has been jeopardised and may pose direct safety risks. Never try to use a gas spring that exhibits tiny dents or bends on its tube. Take it out of use and follow the instructions in the section entitled "Recycling".
  - c. Gas springs where either the warning text, manufacturing date or part number has been removed by external action.
4. Our gas springs are designed for ambient temperatures of between  $-30$  and  $+80^{\circ}\text{C}$ . If possible, avoid intensive use at the extremes of this temperature range. Reducing/increasing ambient temperature also means a reduction/increase in gas spring force.
5. Gas springs are designed to handle axial loads. Avoid radial forces (lateral forces). Choose as big a cross section as possible.
6. We always recommend the use of external end stops in the application. Do not exert any external force during the stroke.
7. Do not lubricate the piston rod with grease or oil, and do not expose the gas spring to oils or solvents.
8. Avoid using non-stainless gas springs in corrosive environments.
9. Do not expose the piston rod to dirt and dust.
10. Long periods of storage may cause the sealing material to age. If storage is necessary, we recommend you adopt a "first in – first out" policy. If a gas spring has been unused for a long period of time, it may require a little more force to press the piston rod in when operated for the first time. This is normal and does not have a negative impact on future use.

If all these points are taken into account, you will have gone some way towards safe and well-functioning use of gas springs. However, Lesjöfors cannot be held liable for the performance or safety of the final application.

### RECYCLING

The majority of a gas spring is made of metal and therefore can be recycled. If you are going to dispose of a gas spring yourself, e.g. if it has been damaged or has otherwise become unusable, bear in mind the following:

1. Depressurise the gas spring by drilling a 3 mm hole 20 mm from the tube end with it fixed in the vertical position and the piston rod down and in max extended position. NB Wear protective goggles, protective clothing and ear defenders when doing this as the spring will make a noise when pierced and you may be exposed to small amounts of oil and metal fragments. See diagram.

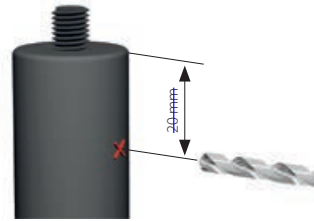

Nitrogen is an inert gas and is neither explosive nor toxic.

2. Drain the oil through the drilled hole by pressing in and pulling out the piston rod repeatedly if necessary. Recycle the waste oil in accordance with local regulations.
3. The gas spring can now be taken to a metal recycling centre in accordance with local regulations.

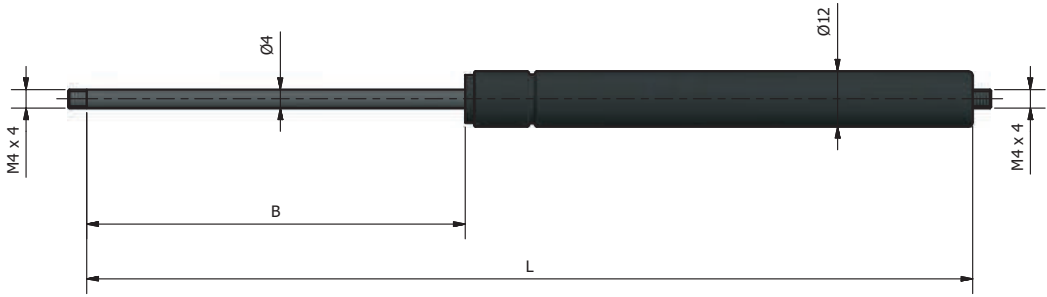

### Gas spring with pneumatic extension speed $\sim 0,15$ m/s

All dimensions are in mm

Force range: 15-130 N

L = Length  $\pm 2$

End fittings: See pages 177-191

B = Stroke

F<sub>1</sub> = Spring force in N

L	B	F <sub>1</sub>	Cat.no
80	25	15	200
80	25	20	201
80	25	30	202
80	25	50	203
80	25	70	204
80	25	90	205
80	25	110	206
80	25	130	207
100	35	15	208
100	35	20	209
100	35	30	210
100	35	50	211
100	35	70	212
100	35	90	213
100	35	110	214
100	35	130	215
120	45	15	216
120	45	20	217
120	45	30	218
120	45	50	219
120	45	70	220
120	45	90	221
120	45	110	222
120	45	130	223
140	55	15	224
140	55	20	225
140	55	30	226
140	55	50	227
140	55	70	228
140	55	90	229
140	55	110	230
140	55	130	231

L	B	F <sub>1</sub>	Cat.no
180	75	15	232
180	75	20	233
180	75	30	234
180	75	50	235
180	75	70	236
180	75	90	237
180	75	110	238
180	75	130	239
220	95	15	240
220	95	20	241
220	95	30	242
220	95	50	243
220	95	70	244
220	95	90	245
220	95	110	246
220	95	130	247

# GAS SPRINGS

TYPE 12-4 E

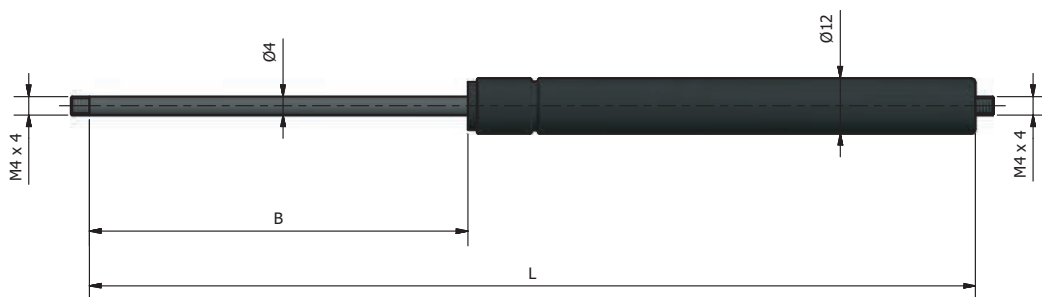

Gas spring with pneumatic extension speed  $\sim 0,3 \text{ m/s}$

All dimensions in mm

Force range: 10-140 N

L = Length  $\pm 2$

End fittings: See pages 177-191

B = Stroke

$F_1$  = Spring force in N

L	B	$F_1$	Cat.no
72	20	10	400
72	20	20	401
72	20	30	402
72	20	40	403
72	20	60	404
72	20	80	405
72	20	110	406
72	20	140	407
92	30	10	408
92	30	20	409
92	30	30	410
92	30	40	411
92	30	60	412
92	30	80	413
92	30	110	414
92	30	140	415
112	40	10	416
112	40	20	417
112	40	30	418
112	40	40	419
112	40	60	420
112	40	80	421
112	40	110	422
112	40	140	423
132	50	10	424
132	50	20	425
132	50	30	426
132	50	40	427
132	50	60	428
132	50	80	429
132	50	110	430
132	50	140	431

L	B	$F_1$	Cat.no
152	60	10	432
152	60	20	433
152	60	30	434
152	60	40	435
152	60	60	436
152	60	80	437
152	60	110	438
152	60	140	439
172	70	10	440
172	70	20	441
172	70	30	442
172	70	40	443
172	70	60	444
172	70	80	445
172	70	110	446
172	70	140	447
192	80	10	448
192	80	20	449
192	80	30	450
192	80	40	451
192	80	60	452
192	80	80	453
192	80	110	454
192	80	140	455
232	100	10	456
232	100	20	457
232	100	30	458
232	100	40	459
232	100	60	460
232	100	80	461
232	100	110	462

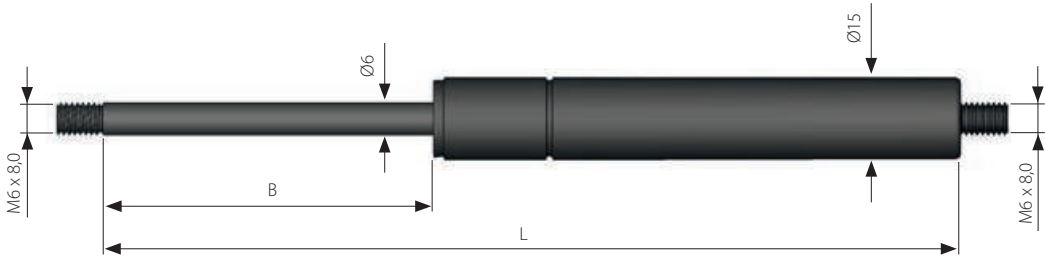

### Conventional gas spring with extension speed $\sim 0.1$ m/s

All dimensions are in mm

L = Length +/- 2

B = Stroke

F1 = Spring force in Newtons

Force range: 40-350 Newtons

End fittings: See pages 177-191

1 kp = 9.80665 Newtons, 1 Newton = 0.10197 kp

L	B	F <sub>1</sub>	Cat.no
127	45	40	4461
127	45	80	4462
127	45	120	4463
127	45	160	4464
127	45	200	4465
127	45	240	4466
127	45	280	4468
127	45	350	4469
156	60	40	4470
156	60	80	4471
156	60	120	4472
156	60	160	4473
156	60	200	4474
156	60	240	4475
156	60	280	4476
156	60	350	4477
181	70	40	4478
181	70	80	4479
181	70	120	4480
181	70	160	4549
181	70	200	4482
181	70	240	4483
181	70	280	4484
181	70	350	4485
221	90	40	4486
221	90	80	4487
221	90	120	4488
221	90	160	4489
221	90	200	4490
221	90	240	4481
221	90	280	4537
221	90	350	4492

L	B	F <sub>1</sub>	Cat.no
236	100	40	8101
236	100	80	8102
236	100	120	8103
236	100	160	8104
236	100	200	8105
236	100	240	8106
236	100	280	8107
236	100	350	8108
273	105	40	4829
273	105	80	4494
273	105	120	4495
273	105	160	4813
273	105	200	4496
273	105	240	4497
273	105	280	4498
273	105	350	4499
303	135	40	4500
303	135	80	4501
303	135	120	4502
303	135	160	4503
303	135	200	4504
303	135	240	4505
303	135	280	4506
303	135	350	4507
378	170	40	8109
378	170	80	8110
378	170	120	8111
378	170	160	8112
378	170	200	8113
378	170	240	8114
378	170	280	8115
378	170	350	8116



# GAS SPRINGS

TYPE 15-6 E

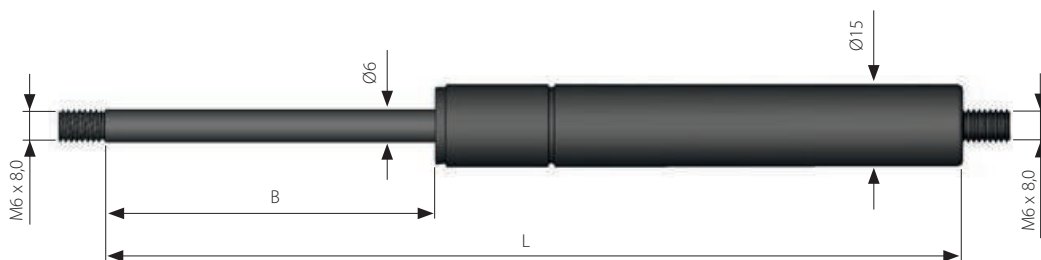

## Conventional gas spring with extension speed ~ 0.3 m/s

All dimensions in mm

L = Length +/- 2

B = Stroke

F<sub>1</sub> = Spring force in Newtons

Force range: 50-400 Newtons

End fittings: See pages 177-191

1 kp = 9.80665 Newtons, 1 Newton = 0.10197 kp

L	B	F <sub>1</sub>	Cat.no
77,5	20	50	9002
77,5	20	100	9003
77,5	20	150	9004
77,5	20	200	9005
77,5	20	250	9006
77,5	20	300	9007
77,5	20	350	9008
77,5	20	400	9009
117,5	40	50	9010
117,5	40	100	9011
117,5	40	150	9012
117,5	40	200	9013
117,5	40	250	9014
117,5	40	300	9015
117,5	40	350	9016
117,5	40	400	9017
156,5	60	50	9018
156,5	60	100	9019
156,5	60	150	9020
156,5	60	200	9021
156,5	60	250	9022
156,5	60	300	9023
156,5	60	350	9024
156,5	60	400	9025
197	80	50	9026
197	80	100	9027
197	80	150	9028
197	80	200	9029
197	80	250	9030
197	80	300	9031
197	80	350	9032
197	80	400	9033

L	B	F <sub>1</sub>	Cat.no
235	100	50	9034
235	100	100	9035
235	100	150	9036
235	100	200	9037
235	100	250	9038
235	100	300	9039
235	100	350	9040
235	100	400	9041
278	120	50	9042
278	120	100	9043
278	120	150	9044
278	120	200	9045
278	120	250	9046
278	120	300	9047
278	120	350	9048
278	120	400	9049
337,5	150	50	9050
337,5	150	100	9051
337,5	150	150	9052
337,5	150	200	9053
337,5	150	250	9054
337,5	150	300	9055
337,5	150	350	9056
337,5	150	400	9057

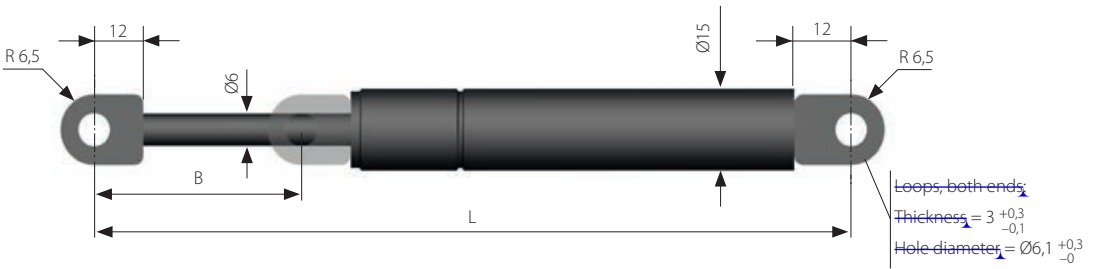

### Conventional gas spring with welded loops, extension speed ~ 0.3 m/s

All dimensions in mm

L = Length +/- 2

B = Stroke

F<sub>1</sub> = Spring force in Newtons

Force range: 50-400 Newtons

End fittings: See pages 177-191

1 kp = 9.80665 Newtons, 1 Newton = 0.10197 kp

L	B	F <sub>1</sub>	Cat.no
106	20	50	9058
106	20	100	9059
106	20	150	9060
106	20	200	9061
106	20	250	9062
106	20	300	9063
106	20	350	9064
106	20	400	9065
146	40	50	9066
146	40	100	9067
146	40	150	9068
146	40	200	9069
146	40	250	9070
146	40	300	9071
146	40	350	9072
146	40	400	9073
186	60	50	9074
186	60	100	9075
186	60	150	9076
186	60	200	9077
186	60	250	9078
186	60	300	9079
186	60	350	9080
186	60	400	9081
224	80	50	9082
224	80	100	9083
224	80	150	9084
224	80	200	9085
224	80	250	9086
224	80	300	9087
224	80	350	9088
224	80	400	9089

L	B	F <sub>1</sub>	Cat.no
264	100	50	9090
264	100	100	9091
264	100	150	9092
264	100	200	9093
264	100	250	9094
264	100	300	9095
264	100	350	9096
264	100	400	9097
305,5	120	50	9098
305,5	120	100	9099
305,5	120	150	9100
305,5	120	200	9101
305,5	120	250	9102
305,5	120	300	9103
305,5	120	350	9104
305,5	120	400	9105
366	150	50	9106
366	150	100	9107
366	150	150	9108
366	150	200	9109
366	150	250	9110
366	150	300	9111
366	150	350	9112
366	150	400	9113

# GAS SPRINGS

TYPE 15-6 ES

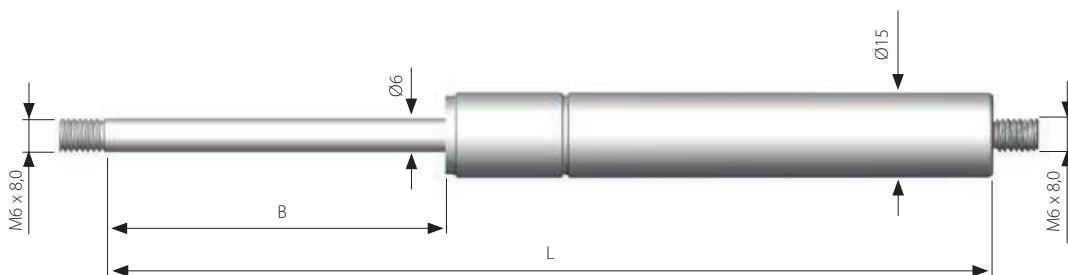

## Conventional stainless steel gas spring, extension speed ~ 0.3 m/s

All dimensions in mm

L = Length +/- 2

B = Stroke

F<sub>1</sub> = Spring force in Newtons

Force range: 50 - 400 Newtons

Material: AISI 316L (E No. 1.4404 / E No. 1.4435)

End fittings: See pages 192-194

1 kg = 9,80665 Newtons, 1 Newton = 0.10197 kg

L	B	F <sub>1</sub>	Cat.no
156,5	60	50	S1160
156,5	60	100	S1161
156,5	60	150	S1162
156,5	60	200	S1163
156,5	60	250	S1164
156,5	60	300	S1165
156,5	60	350	S1166
156,5	60	400	S1167
197	80	50	S1168
197	80	100	S1169
197	80	150	S1170
197	80	200	S1171
197	80	250	S1172
197	80	300	S1173
197	80	350	S1174
197	80	400	S1175
235	100	50	S1176
235	100	100	S1177
235	100	150	S1178
235	100	200	S1179
235	100	250	S1180
235	100	300	S1181
235	100	350	S1182
235	100	400	S1183

L	B	F <sub>1</sub>	Cat.no
278	120	50	S1184
278	120	100	S1185
278	120	150	S1186
278	120	200	S1187
278	120	250	S1188
278	120	300	S1189
278	120	350	S1190
278	120	400	S1191
337,5	150	50	S1192
337,5	150	100	S1193
337,5	150	150	S1194
337,5	150	200	S1195
337,5	150	250	S1196
337,5	150	300	S1197
337,5	150	350	S1198
337,5	150	400	S1199

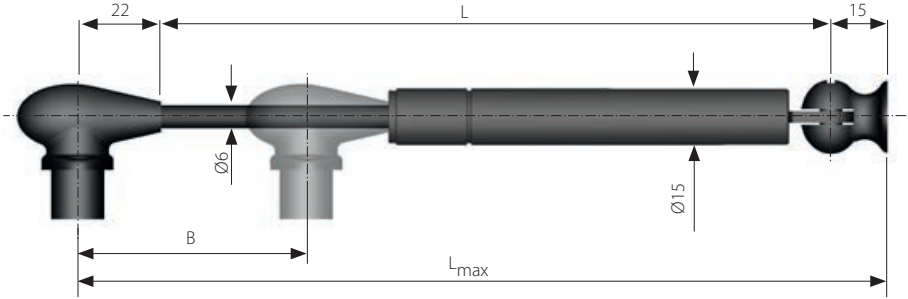

### Conventional gas spring for furniture applications

Ideal for overhanging doors. Available in two variants, which cover most requirements. Plastic end fittings are included.

All dimensions are in mm.

$L_{max}$  = Length +/- 2

B = Stroke

$F_1$  = Spring force in Newtons

Extension speed: ~ 0.1 m/s

Colours: Black products are supplied with black end fittings 8962 and 8963. Grey products have a chrome piston rod and are supplied with grey end fittings 1115 and 1116. See page 188.

1 kg = 9.80665 Newtons, 1 Newton = 0.10197 kg

$L_{max}$	L	B	$F_1$	Colour	Cat. no.
259	222	90	100	Black	0883
259	222	90	150	Black	0884
259	222	90	100	Grey	0885
259	222	90	150	Grey	0886

### Fitting instructions

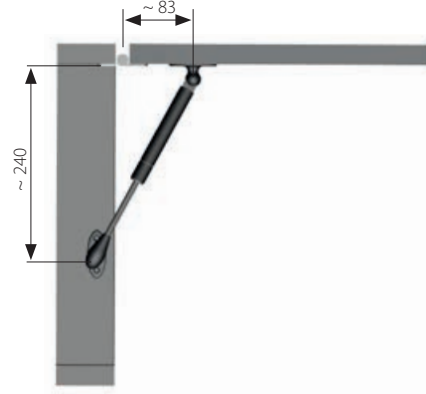

### Choice of force and number of gas springs

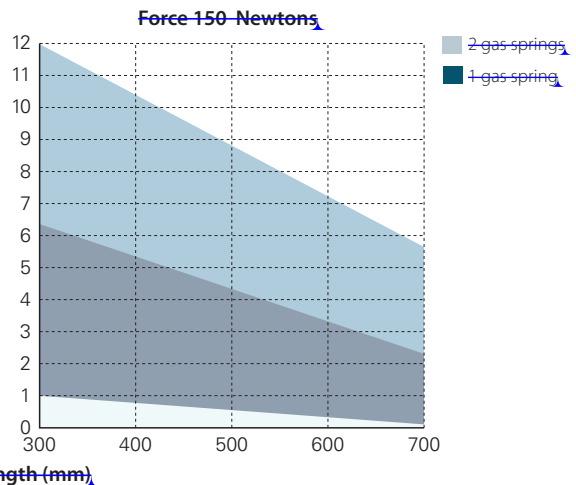
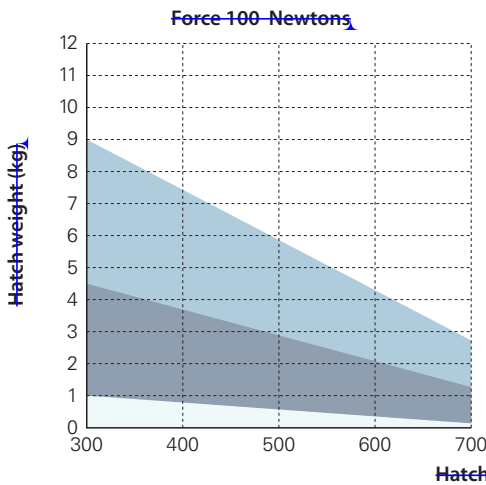

# GAS SPRINGS

TYPE 18-8 L

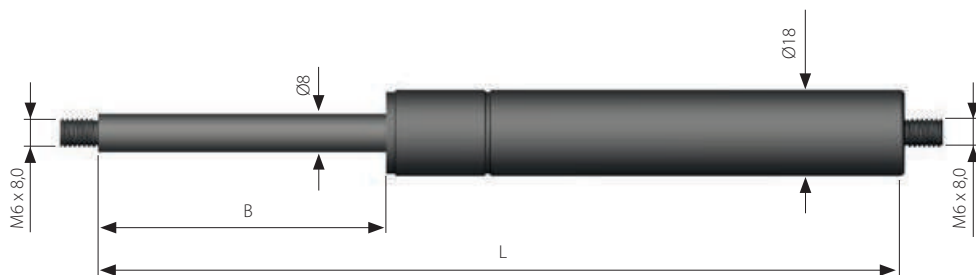

## Conventional gas spring with extension speed ~ 0.1 m/s

All dimensions in mm

L = Length +/- 2

B = Stroke

F<sub>1</sub> = Spring force in Newtons

Force range: 100-600 Newtons

End fittings: See pages 177-191

1 kp = 9.80665 Newtons, 1 Newton = 0.10197 kp

L	B	F <sub>1</sub>	Cat. no.
158	50	400	4508
158	50	500	4509
158	50	600	4852
201	80	400	4831
201	80	500	4511
201	80	600	4512
238	100	400	4513
238	100	500	4708
238	100	600	4515
293	125	100	4516
293	125	150	4517
293	125	200	4518
293	125	300	4553
293	125	400	4519
293	125	500	4520
293	125	600	4521
353	150	100	4522
353	150	150	4523
353	150	200	4524
353	150	300	4525
353	150	400	4526
353	150	500	4527
353	150	600	4528
398	175	100	8117
398	175	150	8118
398	175	200	8119
398	175	300	8120
398	175	400	8121
398	175	500	8122
398	175	600	8123

L	B	F <sub>1</sub>	Cat. no.
453	200	100	4529
453	200	150	4530
453	200	200	4531
453	200	300	4532
453	200	400	4533
453	200	500	4534
453	200	600	4535
503	225	100	8124
503	225	150	8125
503	225	200	8126
503	225	300	8127
503	225	400	8128
503	225	500	8129
503	225	600	8130
556	255	100	4536
556	255	150	4810
556	255	200	4538
556	255	300	4510
556	255	400	4853
556	255	500	4540
556	255	600	4550

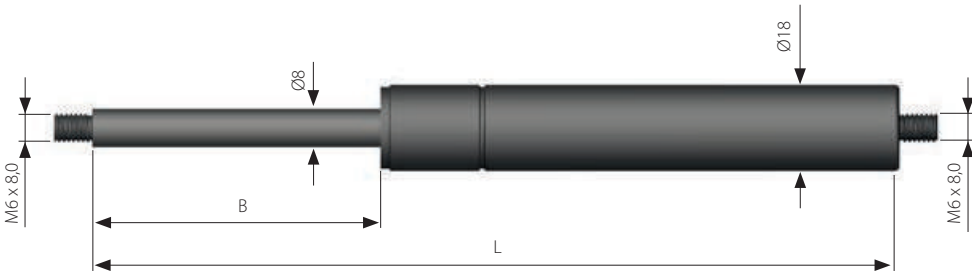

### Conventional gas spring with extension speed ~ 0.3 m/s

All dimensions in mm

L = Length +/- 2

B = Stroke

F<sub>1</sub> = Spring force in Newtons

Force range: 100-750 Newtons

End fittings: See pages 177-191

1 kp = 9.80665 Newtons, 1 Newton = 0.10197 kp

L	B	F <sub>1</sub>	Cat.no
168	60	500	9114
168	60	600	9115
168	60	750	9116
248	100	500	9117
248	100	600	9118
248	100	750	9119
328	140	400	9120
328	140	500	9121
328	140	600	9122
328	140	750	9123
367	160	100	9338
367	160	150	9339
367	160	200	9340
367	160	250	9341
367	160	300	9342
367	160	350	9343
367	160	400	9344
367	160	500	9345
367	160	600	9346
367	160	750	9347
447,5	200	100	9124
447,5	200	150	9125
447,5	200	200	9126
447,5	200	250	9127
447,5	200	300	9128
447,5	200	350	9129
447,5	200	400	9130
447,5	200	500	9131
447,5	200	600	9132
447,5	200	750	9133

L	B	F <sub>1</sub>	Cat.no
489	220	100	9134
489	220	150	9135
489	220	200	9136
489	220	250	9137
489	220	300	9138
489	220	350	9139
489	220	400	9140
489	220	500	9141
489	220	600	9142
489	220	750	9143
547,5	250	100	9144
547,5	250	150	9145
547,5	250	200	9146
547,5	250	250	9147
547,5	250	300	9148
547,5	250	350	9149
547,5	250	400	9150
547,5	250	500	9151
547,5	250	600	9152
547,5	250	750	9153

# GAS SPRINGS

TYPE 18-8 EW

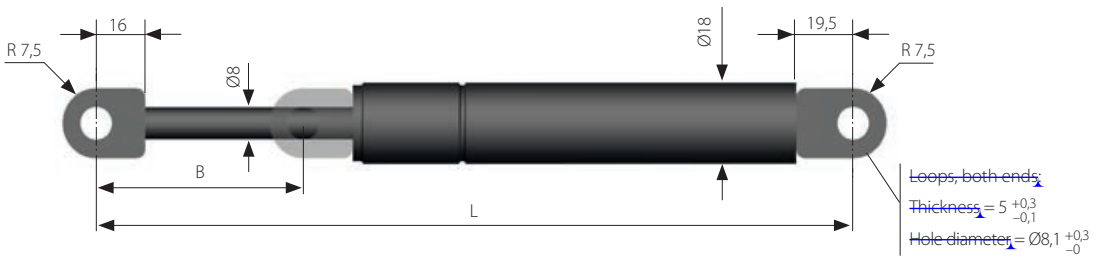

Conventional gas spring with welded loops, extension speed  $\sim 0.3 \text{ m/s}$

All dimensions in mm

L = Length  $\pm 2$

B = Stroke

F<sub>1</sub> = Spring force in Newtons

Force range: 100-750 Newtons

End fittings: See pages 177-191

1 kp = 9.80665 Newtons, 1 Newton = 0.10197 kp

L	B	F <sub>1</sub>	Cat.no
206,5	60	500	9154
206,5	60	600	9155
206,5	60	750	9156
246,5	80	500	9157
246,5	80	600	9158
246,5	80	750	9159
285,5	100	500	9160
285,5	100	600	9161
285,5	100	750	9162
326,5	120	500	9163
326,5	120	600	9164
326,5	120	750	9165
364,5	140	400	9166
364,5	140	500	9167
364,5	140	600	9168
364,5	140	750	9169
407,5	160	100	9170
407,5	160	150	9171
407,5	160	200	9172
407,5	160	250	9173
407,5	160	300	9174
407,5	160	350	9175
407,5	160	400	9176
407,5	160	500	9177
407,5	160	600	9178
407,5	160	750	9179
447	180	100	9180
447	180	150	9181
447	180	200	9182
447	180	250	9183
447	180	300	9184
447	180	350	9185
447	180	400	9186
447	180	500	9187
447	180	600	9188
447	180	750	9189

L	B	F <sub>1</sub>	Cat.no
485,5	200	100	9190
485,5	200	150	9191
485,5	200	200	9192
485,5	200	250	9193
485,5	200	300	9194
485,5	200	350	9195
485,5	200	400	9196
485,5	200	500	9197
485,5	200	600	9198
485,5	200	750	9199
525,5	220	100	9200
525,5	220	150	9201
525,5	220	200	9202
525,5	220	250	9203
525,5	220	300	9204
525,5	220	350	9205
525,5	220	400	9206
525,5	220	500	9207
525,5	220	600	9208
525,5	220	750	9209
586,5	250	100	9210
586,5	250	150	9211
586,5	250	200	9212
586,5	250	250	9213
586,5	250	300	9214
586,5	250	350	9215
586,5	250	400	9216
586,5	250	500	9217
586,5	250	600	9218
586,5	250	750	9219

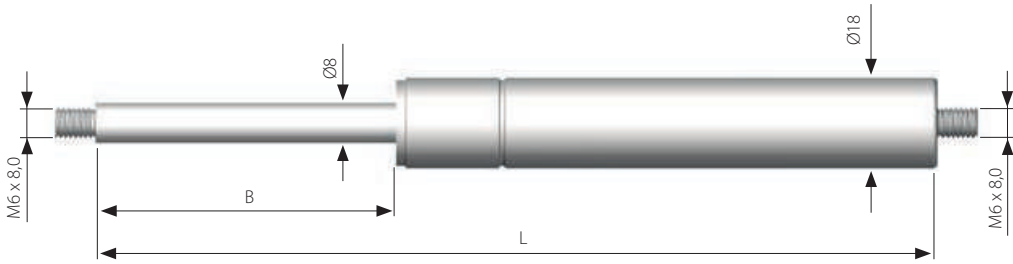

### Conventional stainless steel gas spring, extension speed ~ 0.3 m/s

All dimensions in mm

L = Length +/- 2

B = Stroke

F<sub>1</sub> = Spring force in Newtons

Force range: 100-750 Newtons

Material: AISI 316L (E No. 1.4404 / E No. 1.4435)

End fittings: See pages 192-194

1 kg = 9.80665 Newtons, 1 Newton = 0.10197 kg

L	B	F <sub>1</sub>	Cat. no.
168	60	100	S1000
168	60	200	S1001
168	60	300	S1002
168	60	400	S1003
168	60	500	S1004
168	60	600	S1005
168	60	750	S1006
206	80	100	S1007
206	80	200	S1008
206	80	300	S1009
206	80	400	S1010
206	80	500	S1011
206	80	600	S1012
206	80	750	S1013
248	100	100	S1014
248	100	200	S1015
248	100	300	S1016
248	100	400	S1017
248	100	500	S1018
248	100	600	S1019
248	100	750	S1020
328	140	100	S1021
328	140	200	S1022
328	140	300	S1023
328	140	400	S1024
328	140	500	S1025
328	140	600	S1026
328	140	750	S1027

L	B	F <sub>1</sub>	Cat. no.
367	160	100	S1028
367	160	200	S1029
367	160	300	S1030
367	160	400	S1031
367	160	500	S1032
367	160	600	S1033
367	160	750	S1034
447,5	200	100	S1035
447,5	200	200	S1036
447,5	200	300	S1037
447,5	200	400	S1038
447,5	200	500	S1039
447,5	200	600	S1040
447,5	200	750	S1041
489	220	100	S1042
489	220	200	S1043
489	220	300	S1044
489	220	400	S1045
489	220	500	S1046
489	220	600	S1047
489	220	750	S1048
547,5	250	100	S1049
547,5	250	200	S1050
547,5	250	300	S1051
547,5	250	400	S1052
547,5	250	500	S1053
547,5	250	600	S1054
547,5	250	750	S1055



# GAS SPRINGS

TYPE 18-8 LV

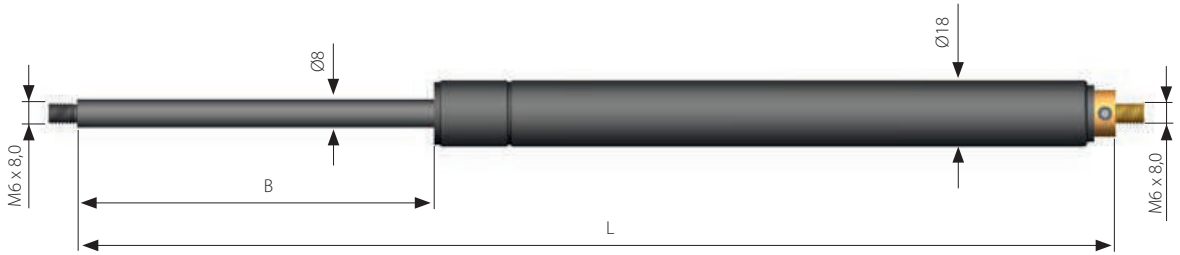

## Conventional gas spring with welded loops, extension speed $\sim 0.3 \text{ m/s}$

All dimensions in mm

L = Length +/- 2

B = Stroke

F<sub>1</sub> = Spring force in Newtons

Force range: All lengths charged to 600 N

End fittings: See pages 177-191

1 kp = 9.80665 Newtons, 1 Newton = 0.10197 kp

Reducing force: See description below

L	B	F <sub>1</sub>	Cat. no.
283	100	600	5480
383	150	600	5481
483	200	600	5482
583	250	600	5483
683	300	600	5484

## Use

This gas spring is supplied with an allen key in order to open the valve at the end of the tube.

Any end fitting can be installed, making it possible to adjust the force when the spring is fitted in the application. In this way, it is possible to estimate an equivalent gas spring with the appropriate fixed force.

Another common area of use is in applications where load can vary from case to case.

## Force adjustment instructions

1. The piston rod must always be pointing downwards when the force is adjusted.
2. Ensure that the valve screw is directed away from you and others when you start the opening process.
3. Open the valve by turning the screw very slowly and carefully anti-clockwise  $\frac{1}{4}$  turn or until you can hear a weak hissing noise. Be prepared to turn the screw back slightly in the opposite direction when you hear the hissing.
4. Do not use excessive force when closing as you may damage the valve.

## NB

Force can only be reduced on this type of gas spring. Once the pressure in the spring has been reduced, Lesjöfors cannot accept returns under any circumstances.

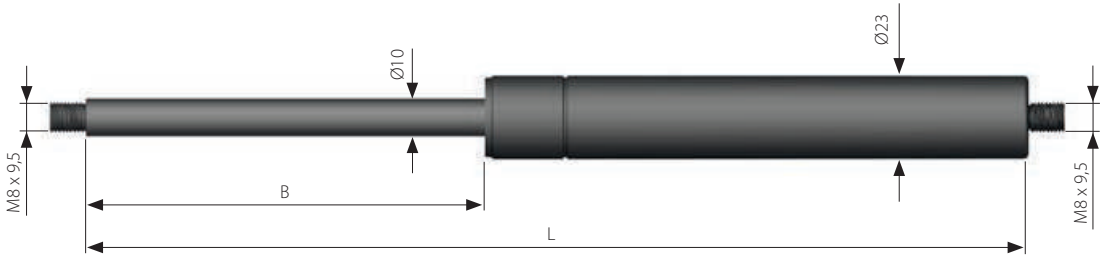

### Conventional gas spring with extension speed $\sim 0.1 \text{ m/s}$

All dimensions in mm

L = Length +/- 2

B = Stroke

F<sub>1</sub> = Spring force in Newtons

Force range: 200-1000 Newtons

End fittings: See pages 177-191

1 kg = 9.80665 Newtons, 1 Newton = 0.10197 kg

L	B	F <sub>1</sub>	Cat.no
218	85	700	4542
218	85	850	4543
218	85	1000	4544
263	110	700	4545
263	110	850	4546
263	110	1000	4547
293	125	700	8131
293	125	850	8132
293	125	1000	8133
338	150	700	4548
338	150	850	4808
338	150	1000	4541
393	175	700	8134
393	175	850	8135
393	175	1000	8136
453	200	700	4551
453	200	850	4552
453	200	1000	4539
553	250	700	4554
553	250	850	4555
553	250	1000	4557

L	B	F <sub>1</sub>	Cat.no
653	300	200	4558
653	300	300	4559
653	300	400	4560
653	300	500	4561
653	300	600	4562
653	300	700	4563
653	300	850	4564
653	300	1000	4565
783	365	200	4566
783	365	300	4567
783	365	400	4568
783	365	500	4569
783	365	600	4570
783	365	700	4571
783	365	850	4572
783	365	1000	4573
874	400	200	8236
874	400	300	8237
874	400	400	8238
874	400	500	8239
874	400	600	8240
874	400	700	8137
874	400	850	8138
874	400	1000	8139

# GAS SPRINGS

TYPE 22-10 E

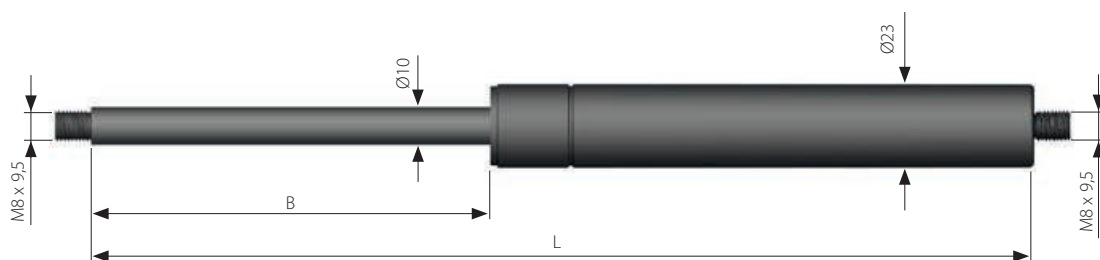

## Conventional gas spring with extension speed $\sim 0.3$ m/s

All dimensions in mm

L = Length +/- 2

B = Stroke

F<sub>1</sub> = Spring force in Newtons

Force range: 150-1200 Newtons

End fittings: See pages 177-191

1 kp = 9,80665 Newtons, 1 Newton = 0.10197 kp

L	B	F <sub>1</sub>	Cat.no
248	100	900	9220
248	100	1000	9221
248	100	1200	9222
348	150	900	9223
348	150	1000	9224
348	150	1200	9225
448	200	900	9226
448	200	1000	9227
448	200	1200	9228
548	250	900	9229
548	250	1000	9230
548	250	1200	9231
648	300	150	9232
648	300	200	9233
648	300	250	9234
648	300	300	9235
648	300	350	9236
648	300	400	9237
648	300	500	9238
648	300	600	9239
648	300	700	9240
648	300	800	9241
648	300	900	9242
648	300	1000	9243
648	300	1200	9244
748	350	150	9245
748	350	200	9246
748	350	250	9247
748	350	300	9248
748	350	350	9249
748	350	400	9250

L	B	F <sub>1</sub>	Cat.no
748	350	500	9251
748	350	600	9252
748	350	700	9253
748	350	800	9254
748	350	900	9255
748	350	1000	9256
748	350	1200	9257
848	400	150	9258
848	400	200	9259
848	400	250	9260
848	400	300	9261
848	400	350	9262
848	400	400	9263
848	400	500	9264
848	400	600	9265
848	400	700	9266
848	400	800	9267
848	400	900	9268
848	400	1000	9269
848	400	1200	9270

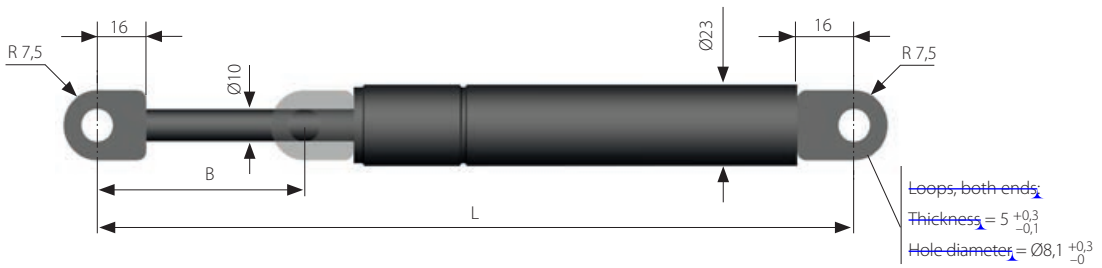

### Conventional gas spring with welded loops, extension speed $\sim 0.3$ m/s

All dimensions in mm

L = Length  $\pm 2$

B = Stroke

F<sub>1</sub> = Spring force in Newtons

Force range: 150-1200 Newtons

End fittings: See pages 177-191

1 kg = 9.80665 Newtons, 1 Newton = 0.10197 kg

L	B	F <sub>1</sub>	Cat.no
283	95	900	9284
283	95	1000	9285
283	95	1200	9286
383	145	900	9287
383	145	1000	9288
383	145	1200	9289
483	195	900	9290
483	195	1000	9291
483	195	1200	9292
586	245	900	9293
586	245	1000	9294
586	245	1200	9295
683	295	150	9296
683	295	200	9297
683	295	250	9298
683	295	300	9299
683	295	350	9300
683	295	400	9301
683	295	500	9302
683	295	600	9303
683	295	700	9304
683	295	800	9305
683	295	900	9306
683	295	1000	9307
683	295	1200	9308

L	B	F <sub>1</sub>	Cat.no
783	345	150	9309
783	345	200	9310
783	345	250	9311
783	345	300	9312
783	345	350	9313
783	345	400	9314
783	345	500	9315
783	345	600	9316
783	345	700	9317
783	345	800	9318
783	345	900	9319
783	345	1000	9320
783	345	1200	9321
883	395	150	9322
883	395	200	9323
883	395	250	9324
883	395	300	9325
883	395	350	9326
883	395	400	9327
883	395	500	9328
883	395	600	9329
883	395	700	9330
883	395	800	9331
883	395	900	9332
883	395	1000	9333

# GAS SPRINGS

TYPE 22-10 ES

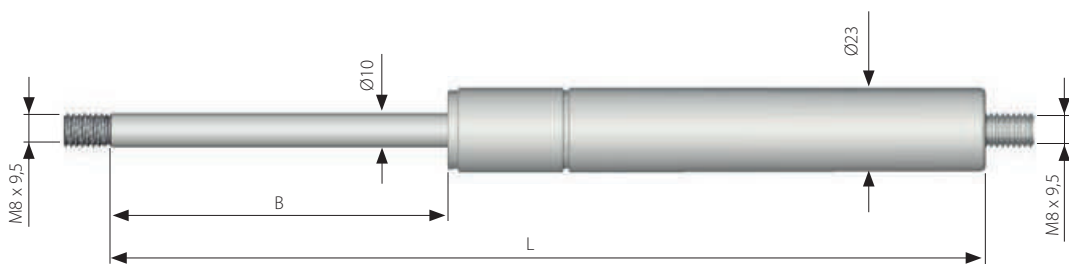

## Conventional stainless steel gas spring, extension speed $\sim 0.3$ m/s

All dimensions in mm

L = Length +/- 2

B = Stroke

F<sub>1</sub> = Spring force in Newtons

Force range: 200–1200 Newtons

Material: AISI 316L (E No. 1.4404 / E No. 1.4435)

End fittings, See pages 192–194

1 kp = 9.80665 Newtons, 1 Newton = 0.10197 kp

L	B	F <sub>1</sub>	Cat. no.
248	100	200	S1066
248	100	300	S1067
248	100	400	S1068
248	100	500	S1069
248	100	600	S1070
248	100	700	S1071
248	100	850	S1072
248	100	1000	S1073
248	100	1200	S1074
348	150	200	S1075
348	150	300	S1076
348	150	400	S1077
348	150	500	S1078
348	150	600	S1079
348	150	700	S1080
348	150	850	S1081
348	150	1000	S1082
348	150	1200	S1083
448	200	200	S1084
448	200	300	S1085
448	200	400	S1086
448	200	500	S1087
448	200	600	S1088
448	200	700	S1089
448	200	850	S1090
448	200	1000	S1091
448	200	1200	S1092
548	250	200	S1093
548	250	300	S1094
548	250	400	S1095
548	250	500	S1096
548	250	600	S1097
548	250	700	S1098
548	250	850	S1099
548	250	1000	S1100
548	250	1200	S1101

L	B	F <sub>1</sub>	Cat. no.
648	300	200	S1102
648	300	300	S1103
648	300	400	S1104
648	300	500	S1105
648	300	600	S1106
648	300	700	S1107
648	300	850	S1108
648	300	1000	S1109
648	300	1200	S1110
748	350	200	S1111
748	350	300	S1112
748	350	400	S1113
748	350	500	S1114
748	350	600	S1115
748	350	700	S1116
748	350	850	S1117
748	350	1000	S1118
748	350	1200	S1119
848	400	200	S1120
848	400	300	S1121
848	400	400	S1122
848	400	500	S1123
848	400	600	S1124
848	400	700	S1125
848	400	850	S1126
848	400	1000	S1127
848	400	1200	S1128

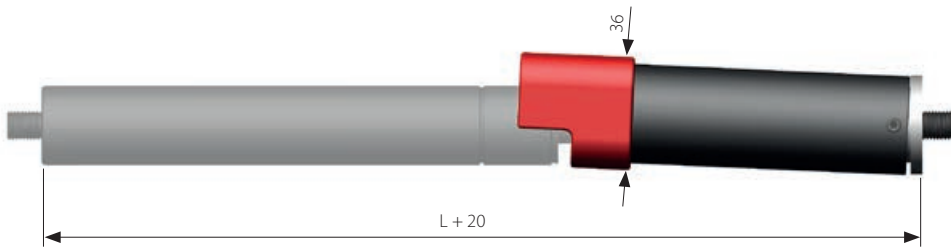

### Supplied fitted on 22-10 L or 22-10 E gas springs

All dimensions in mm

L = Length +/- 2

B = Stroke

Endfittings: See pages 177-191

Name	Fits stroke B	Cat.no
SL-22 100	100	6843
SL-22 150	150	6844
SL-22 200	200	6845
SL-22 250	250	6846
SL-22 300	300	6847
SL-22 350	350	6848
SL-22 400	400	6849

### Use

This safety lock is designed to be fitted to the gas spring piston rod thread. It has a built-in spring function that means that it is automatically folded in behind the end of the tube once the gas spring is fully extended. If the stop is not manually depressed, it will not be possible to compress the gas spring. The lock is released using the plastic handle.

This function is useful if you want to be certain that no external forces, e.g. strong outdoor winds, cause a hatch or similar to be closed unintentionally.

There are also other examples of situations where you might not want equipment to fold up, e.g. if you have folded up a seat to allow passengers to pass by.

### NB

- Safety locks increase structure length L on the gas spring by 20 mm.
- Safety locks are not supplied separately — they must always be ordered with a 22-10 L or 22-10 E gas spring.
- To ensure that the safety stop fits, stroke B must be exactly as shown in the table.

# GAS SPRINGS

TYPE 28-14 L

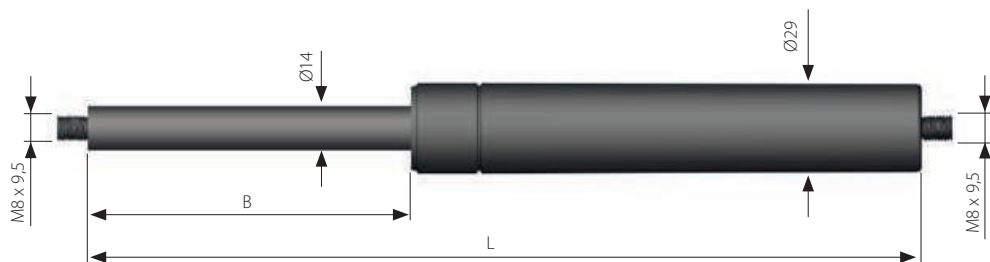

## Conventional gas spring with extension speed $\sim 0.1$ m/s

All dimensions in mm

L = Length  $\pm 2$

B = Stroke

F<sub>1</sub> = Spring force in Newtons

Force range: 1200-2000 Newtons

End fittings: See pages 177-191

1 kp = 9.80665 Newtons, 1 Newton = 0.10197 kp

L	B	F <sub>1</sub>	Cat.-no.
258	100	1200	4574
258	100	1600	4575
258	100	2000	4576
308	125	1200	8140
308	125	1600	8141
308	125	2000	8142
368	150	1200	4577
368	150	1600	4578
368	150	2000	4579
408	175	1200	8143
408	175	1600	8144
408	175	2000	8145
468	200	1200	4580
468	200	1600	4581
468	200	2000	4582

L	B	F <sub>1</sub>	Cat.-no.
568	250	1200	4583
568	250	1600	4584
568	250	2000	4585
668	300	1200	4586
668	300	1600	4587
668	300	2000	4588
768	350	1200	8146
768	350	1600	8147
768	350	2000	8148
874	400	1200	4589
874	400	1600	4590
874	400	2000	4591

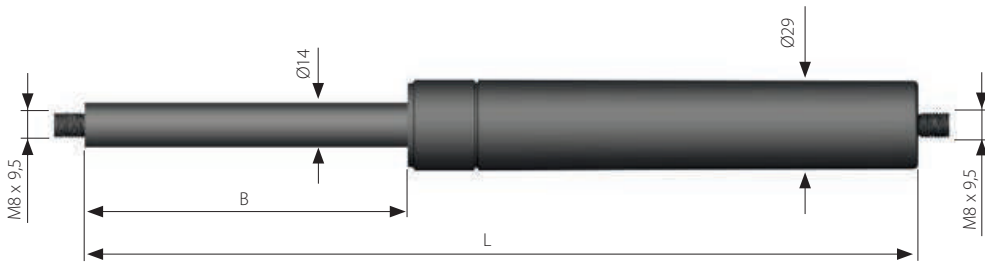

### Conventional gas spring with extension speed ~ 0.3 m/s

All dimensions in mm

L = Length +/- 2

B = Stroke

F<sub>1</sub> = Spring force in Newtons

Force range: 500-2000 Newtons

End fittings: See pages 177-191

1 kp = 9.80665 Newtons, 1 Newton = 0.10197 kp

L	B	F <sub>1</sub>	Cat.no
268	100	1300	9334
268	100	1500	9335
268	100	1700	9336
268	100	2000	9337
468	200	1300	9379
468	200	1500	9380
468	200	1700	9381
468	200	2000	9382
668	300	1300	9350
668	300	1500	9351
668	300	1700	9352
668	300	2000	9353
874	400	1300	9358
874	400	1500	9359
874	400	1700	9360
874	400	2000	9361

L	B	F <sub>1</sub>	Cat.no
1070	500	500	9362
1070	500	600	9363
1070	500	700	9364
1070	500	800	9365
1070	500	900	9366
1070	500	1000	9367
1070	500	1100	9368
1070	500	1300	9369
1070	500	1500	9370
1070	500	1700	9371
1070	500	2000	9372



# GAS SPRINGS

TYPE 40-20

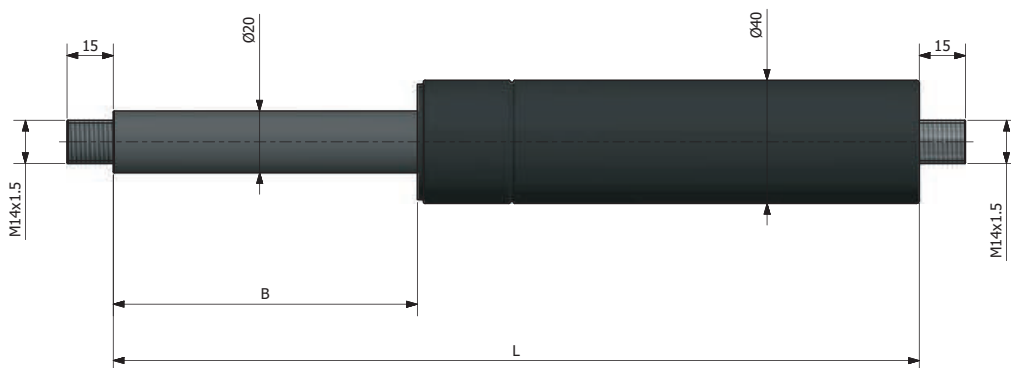

## Conventional gas spring with extension speed $\sim 0.3$ m/s

All dimensions in mm

L = Length +/- 2

B = Stroke

F<sub>1</sub> = Spring force in Newtons

Force range: 2400 – 4000 Newtons

End fittings: See page 178

1 kp = 9.80665 Newtons, 1 Newton = 0.10197 kp

L	B	F <sub>1</sub>	Cat.-no.
320	100	2400	62000
320	100	2800	62001
320	100	3200	62002
320	100	3600	62003
320	100	4000	62004
520	200	2400	62005
520	200	2800	62006
520	200	3200	62007
520	200	3600	62008
520	200	4000	62009
720	300	2400	62010
720	300	2800	62011
720	300	3200	62012
720	300	3600	62013
720	300	4000	62014

L	B	F <sub>1</sub>	Cat.-no.
920	400	2400	62015
920	400	2800	62016
920	400	3200	62017
920	400	3600	62018
920	400	4000	62019
1120	500	2400	62020
1120	500	2800	62021
1120	500	3200	62022
1120	500	3600	62023
1120	500	4000	62024